



Certification acc. to ASME

1 Involved Parties



Involved Parties

2 Steps for ASME Certification

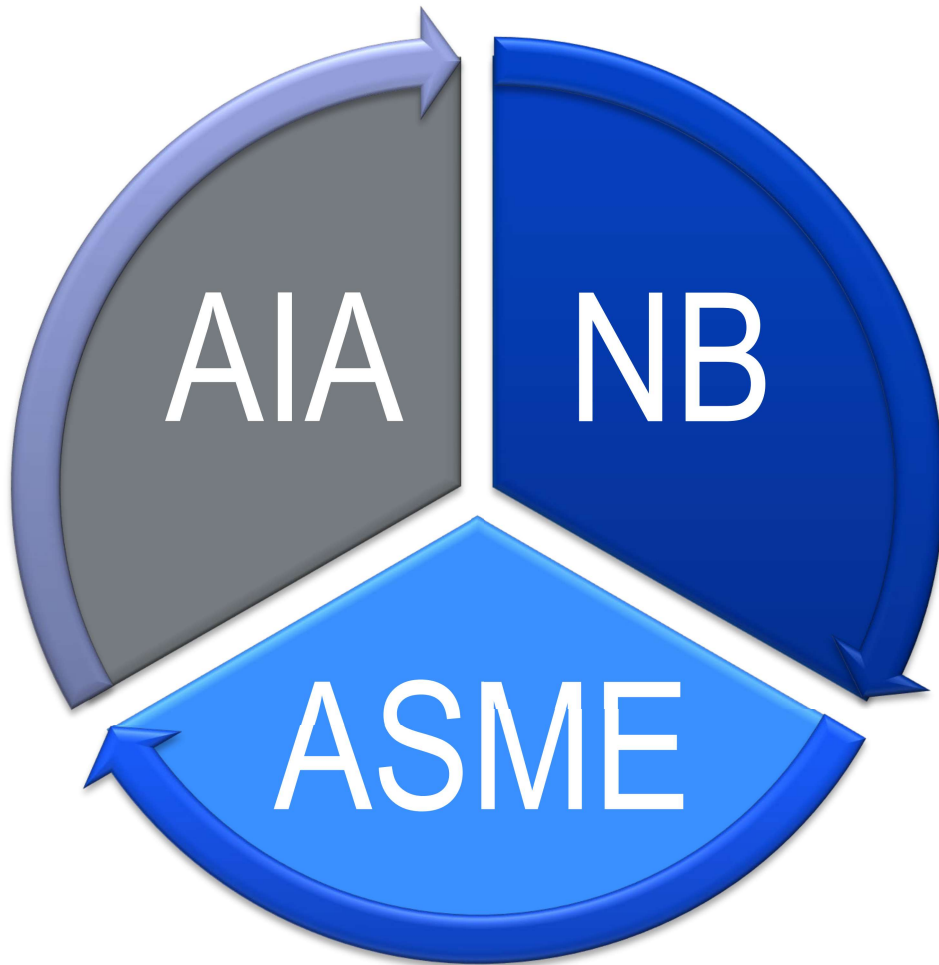



The **A**merican
Society of
Mechanical
Engineers

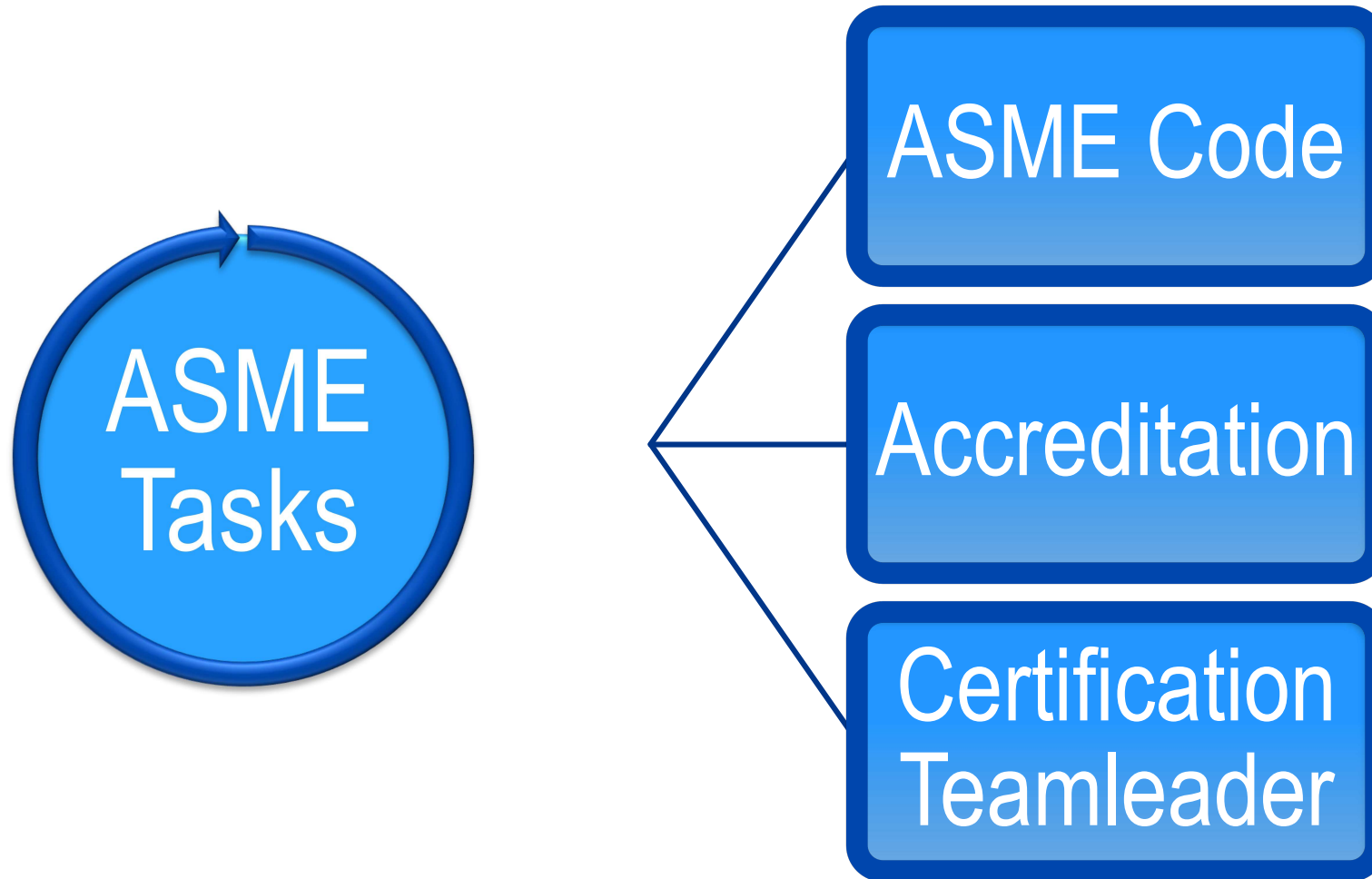

1 Involved Parties

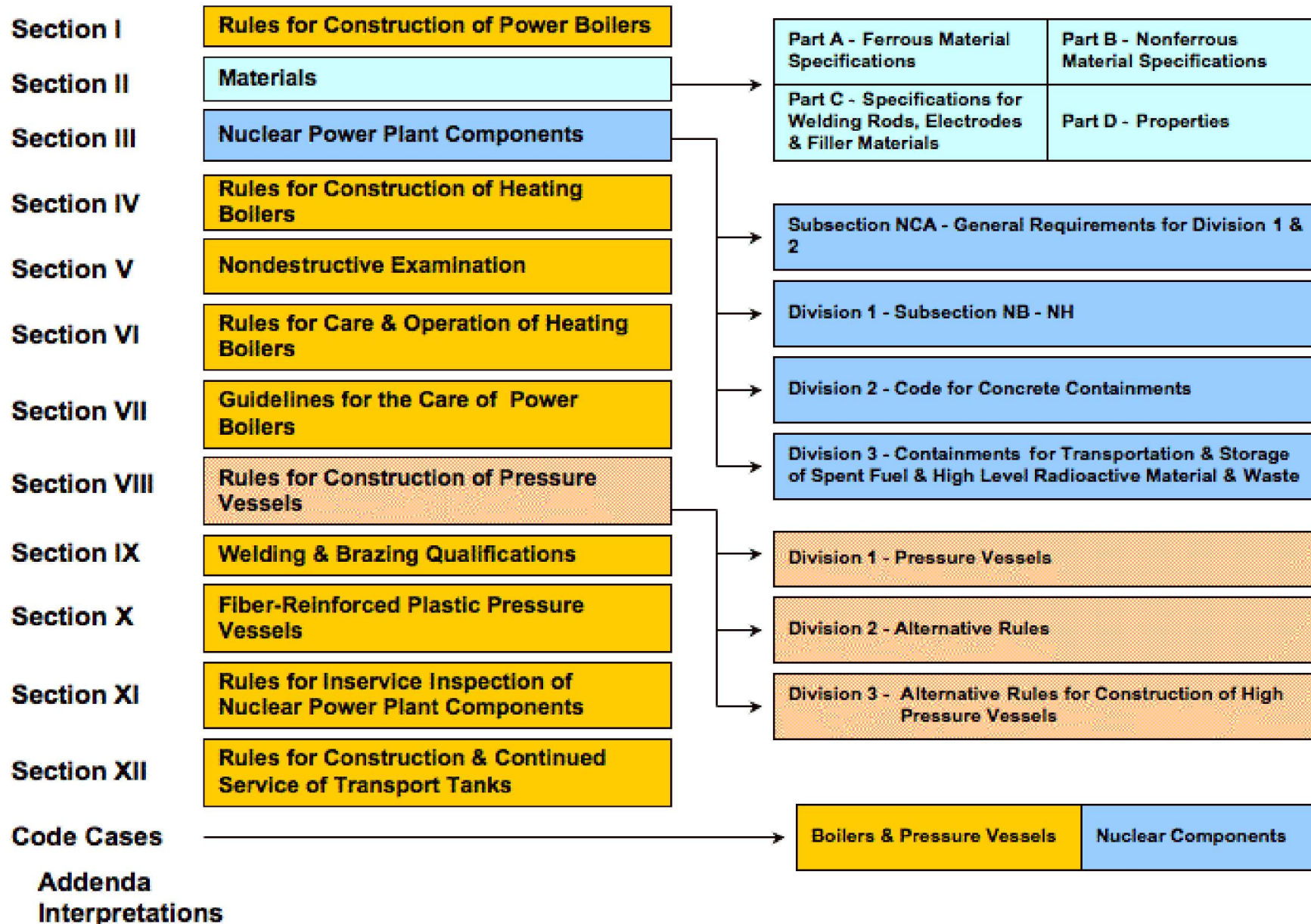



**Authorized
Inspection
Agency**

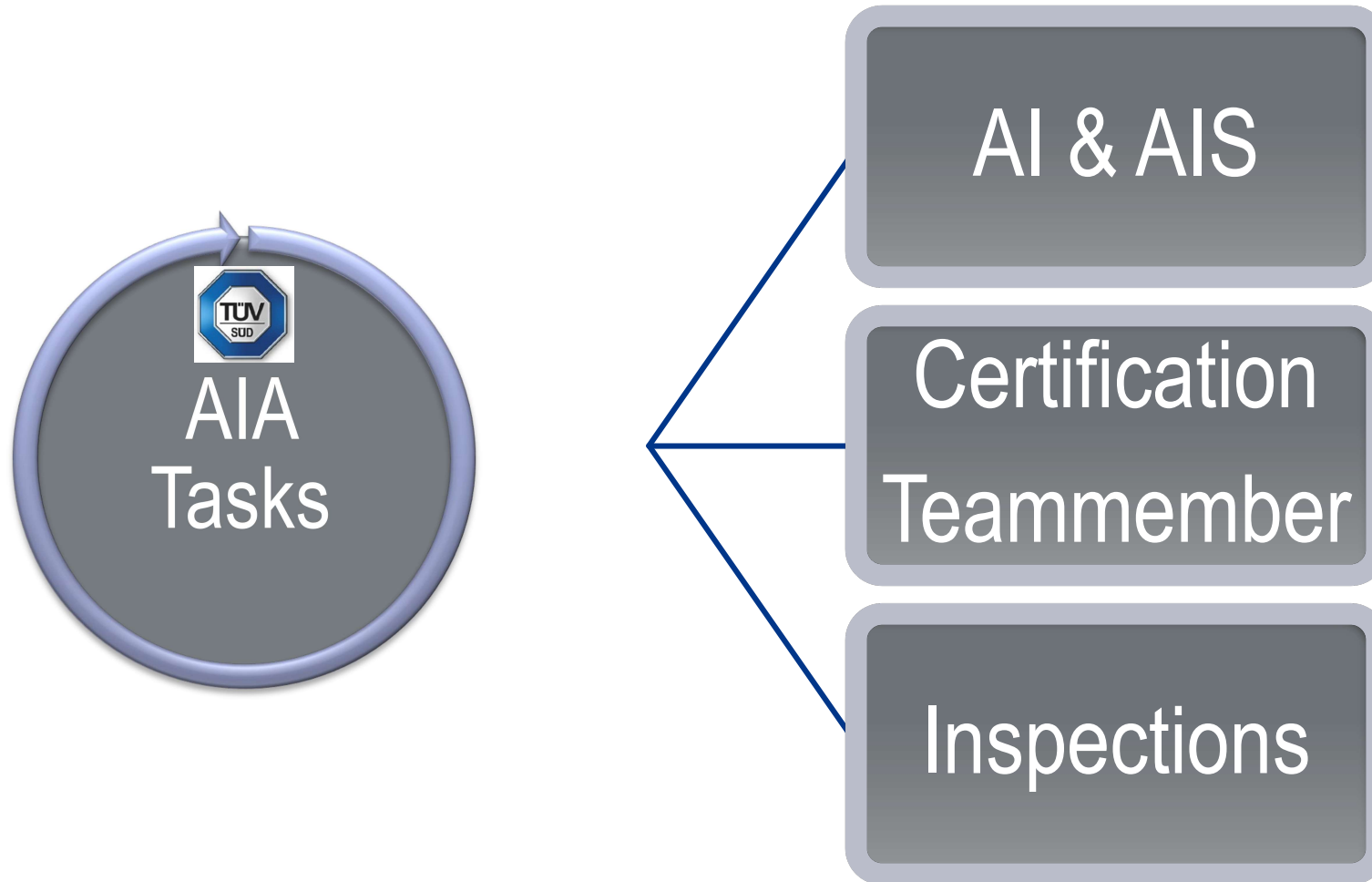

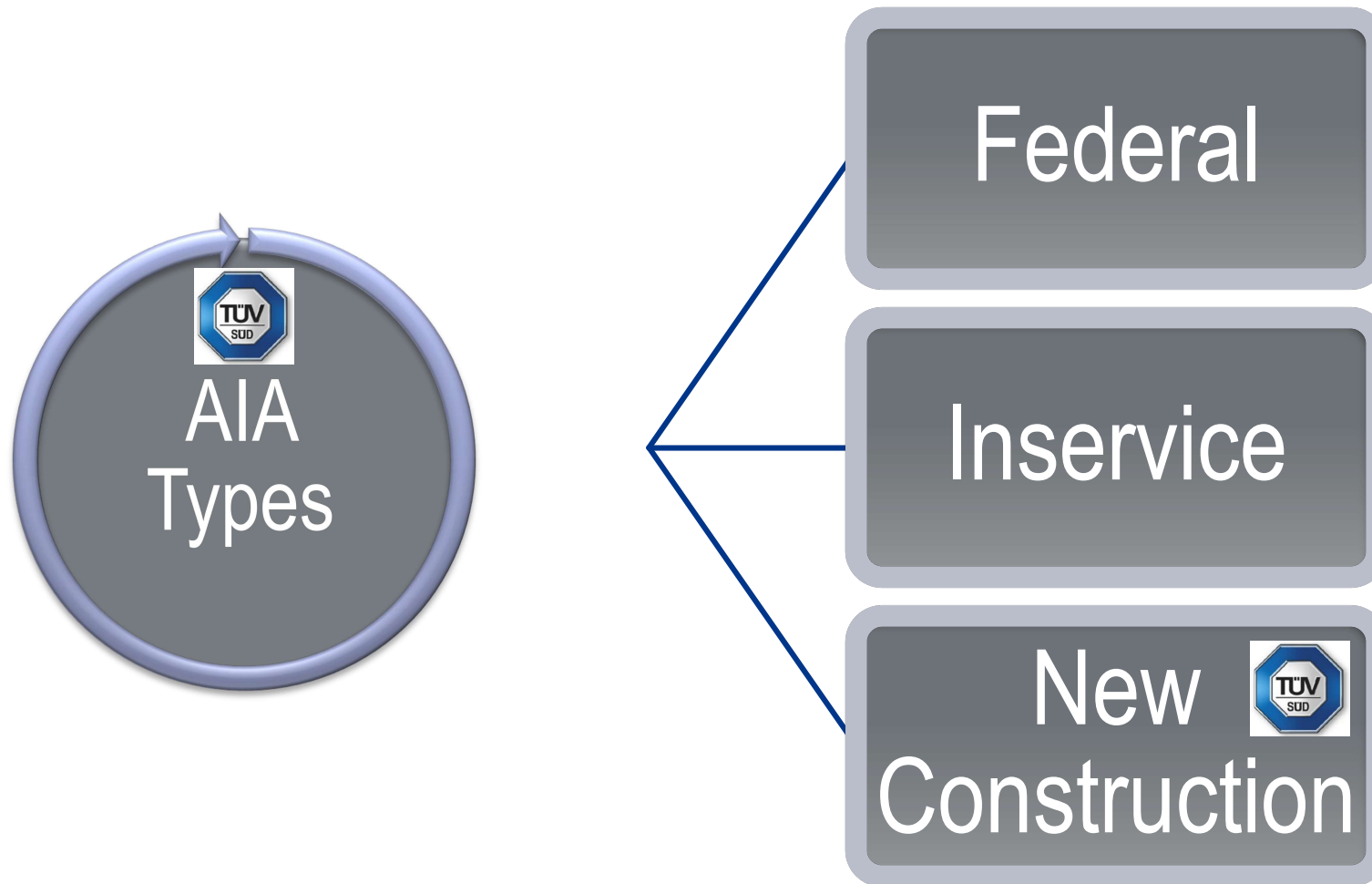



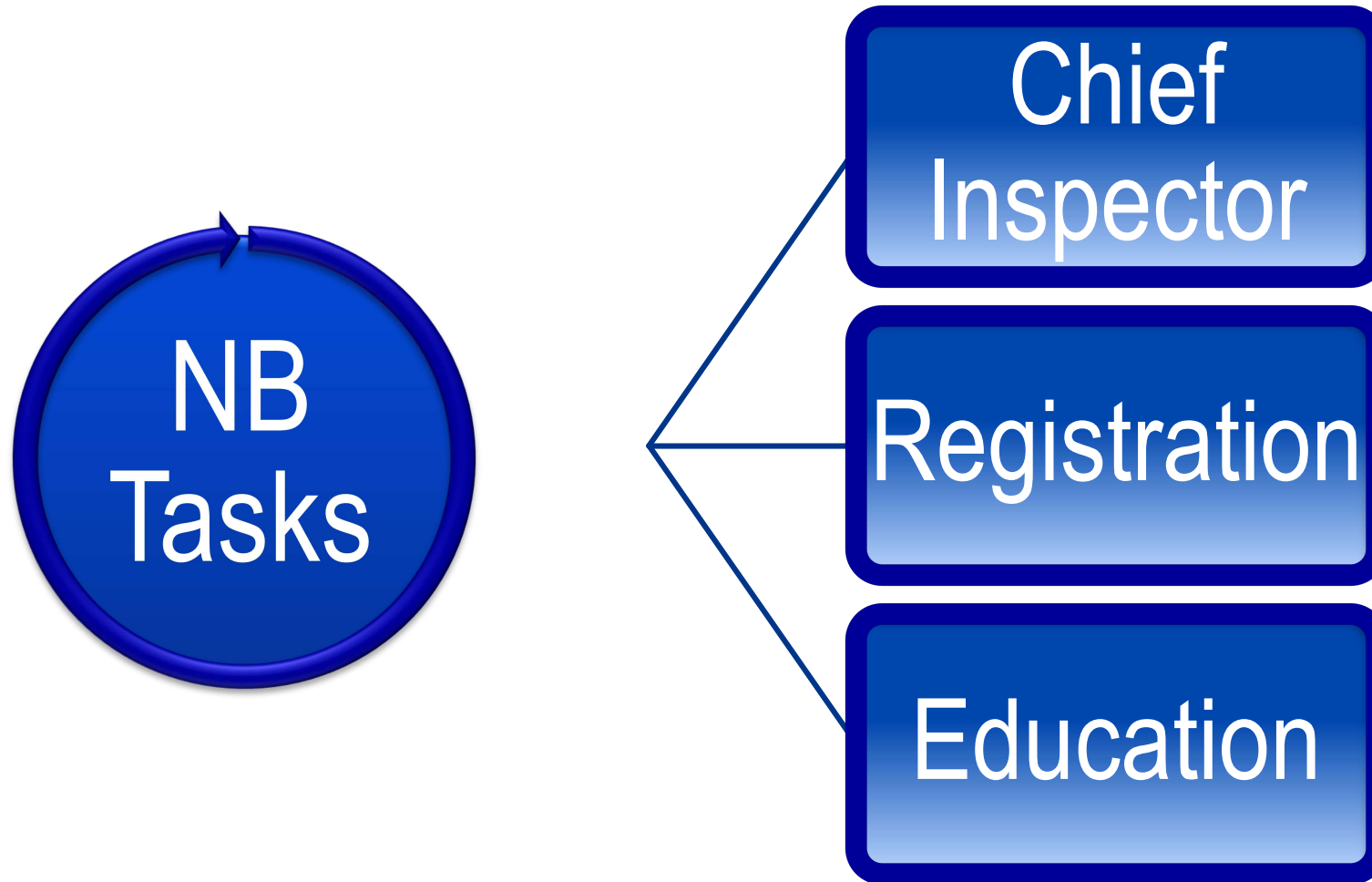

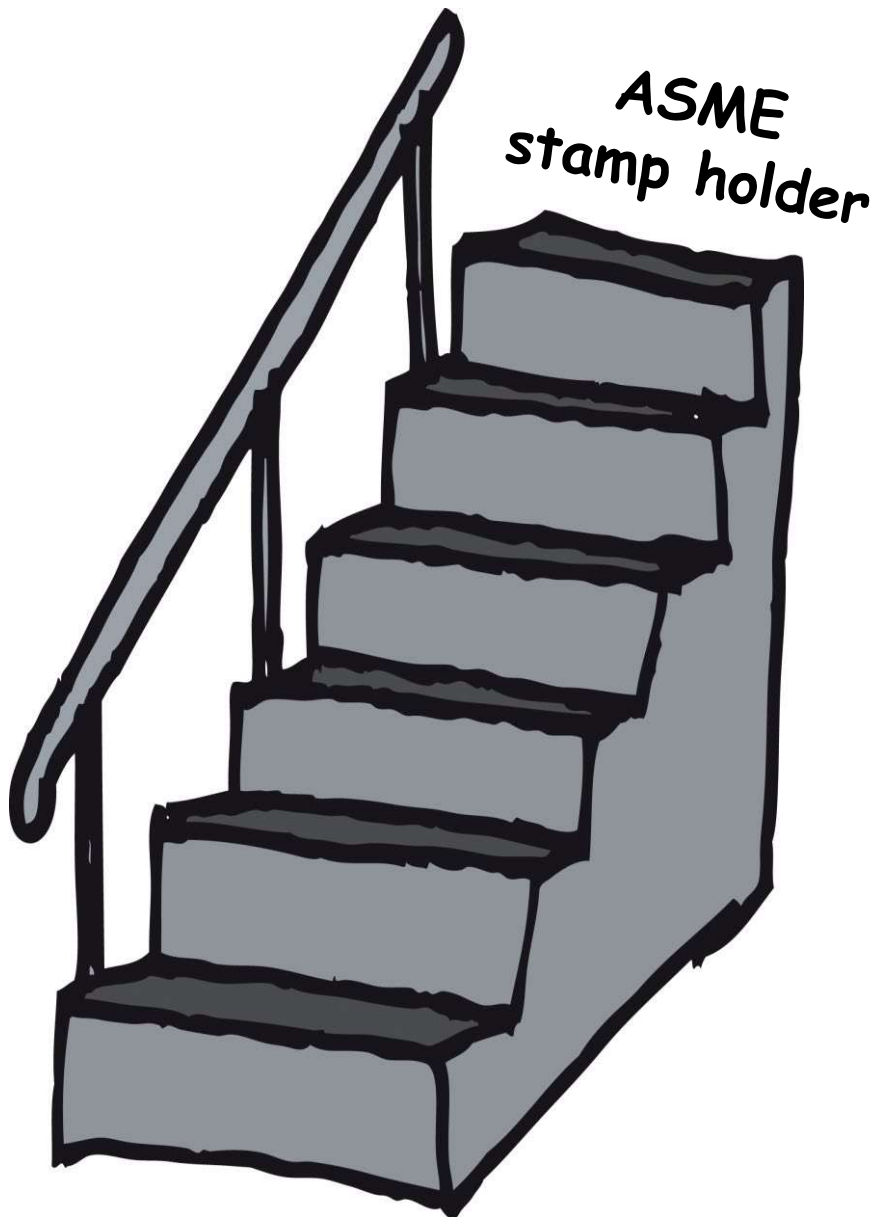

1 Involved Parties

2 Steps for ASME Certification

3 PQR / WPQ / WPS

4 Material

5 Subcontracting (incl. NDT)



- 1 • Contract with AIA
- 2 • Application for ASME Certification
- 3 • Fees
- 4 • Purchase of ASME Code Books
- 5 • Preparation for the Joint Review
- 6 • Joint Review
- 7 • Issue of Certificate

- 1 • Contract with AIA

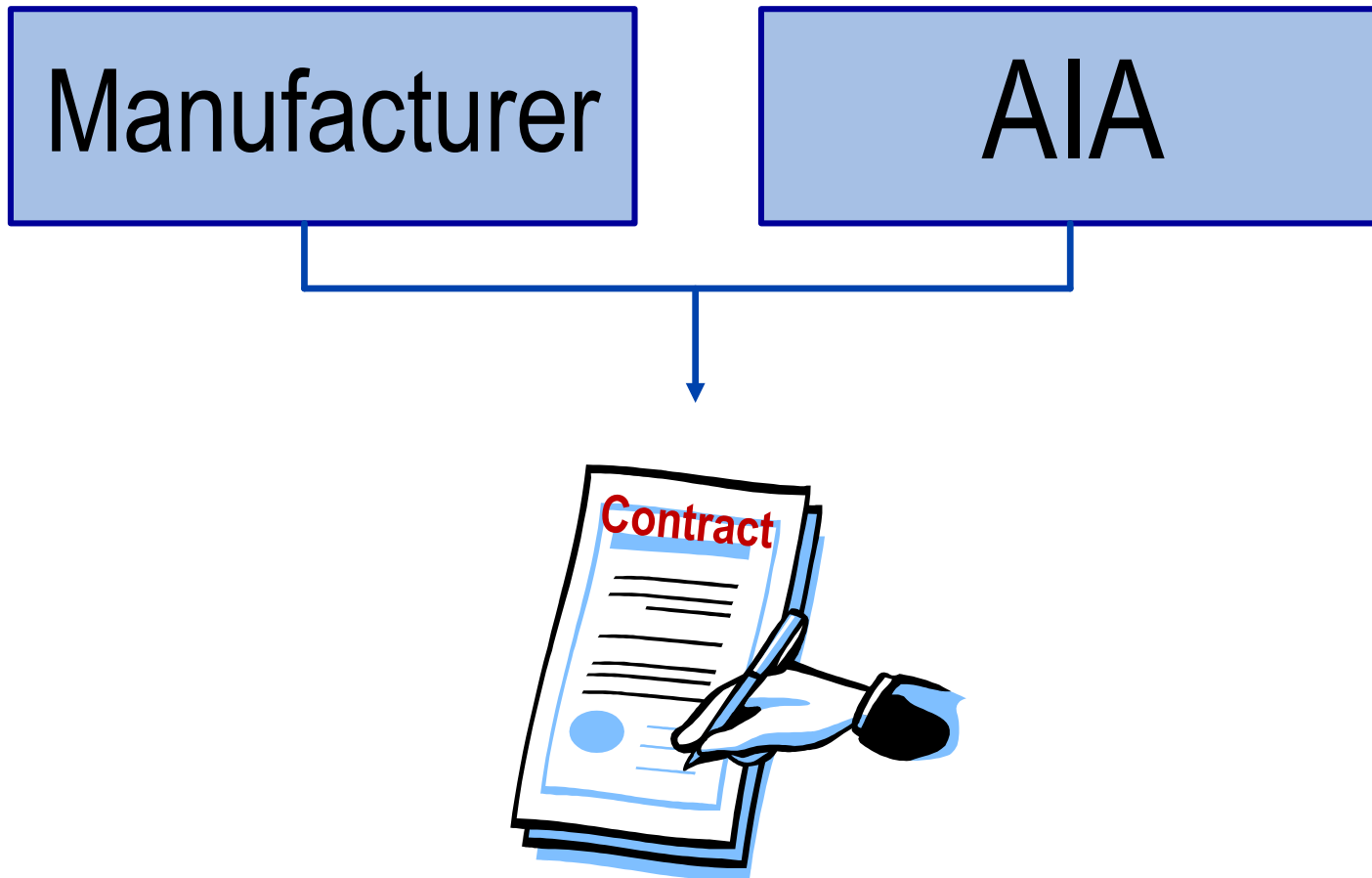

2

- Application for ASME Certification

Manufacturer



ASME

3

• Fees

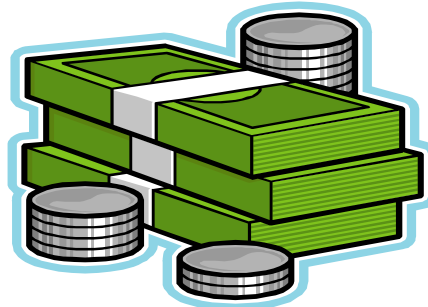
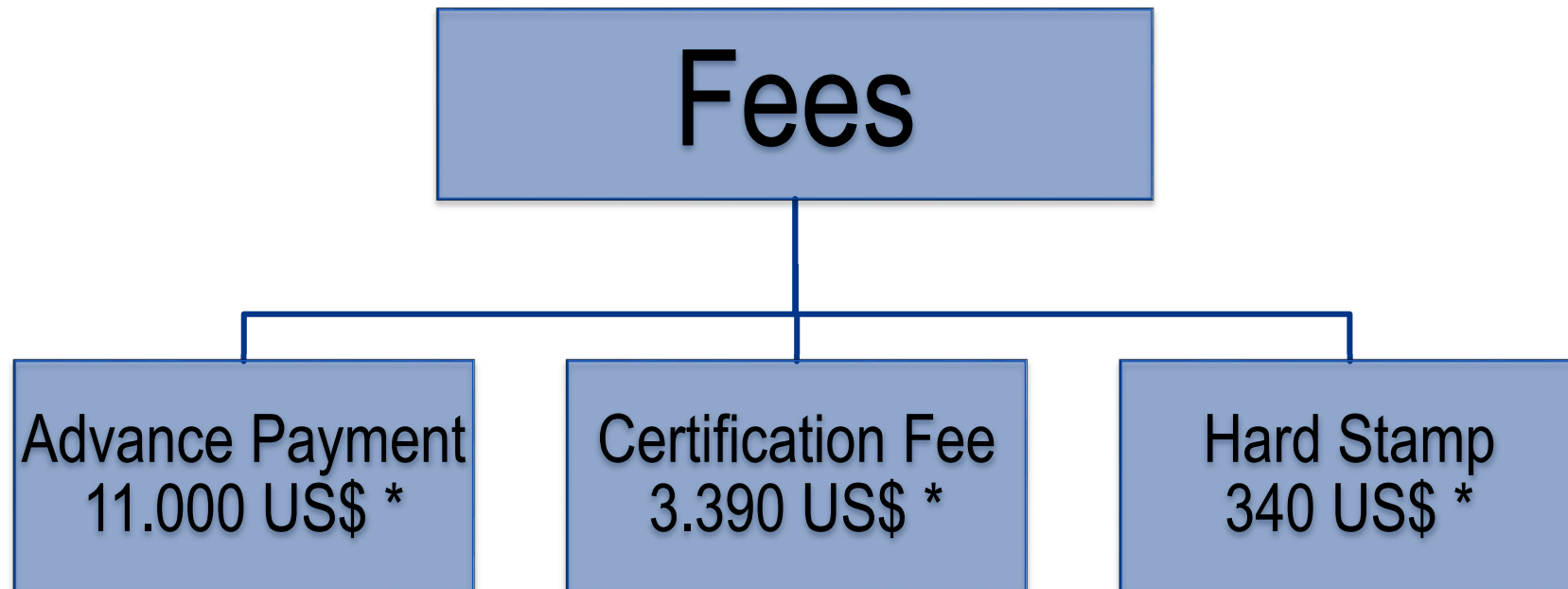

* July 2017

4

- Purchase of ASME Code Books

Package for Sec. VIII, Div. 1

Sec. VIII, Div. 1

Sec. II,
Part A,B,C,D

Sec. V

Sec. IX

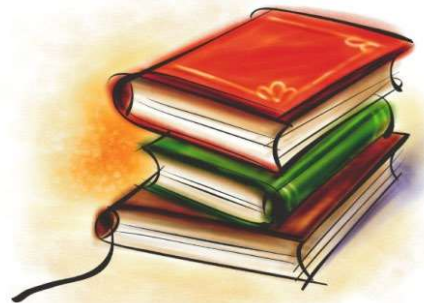

(approx. 5000 US\$)

5

- Preparation for the Joint Review

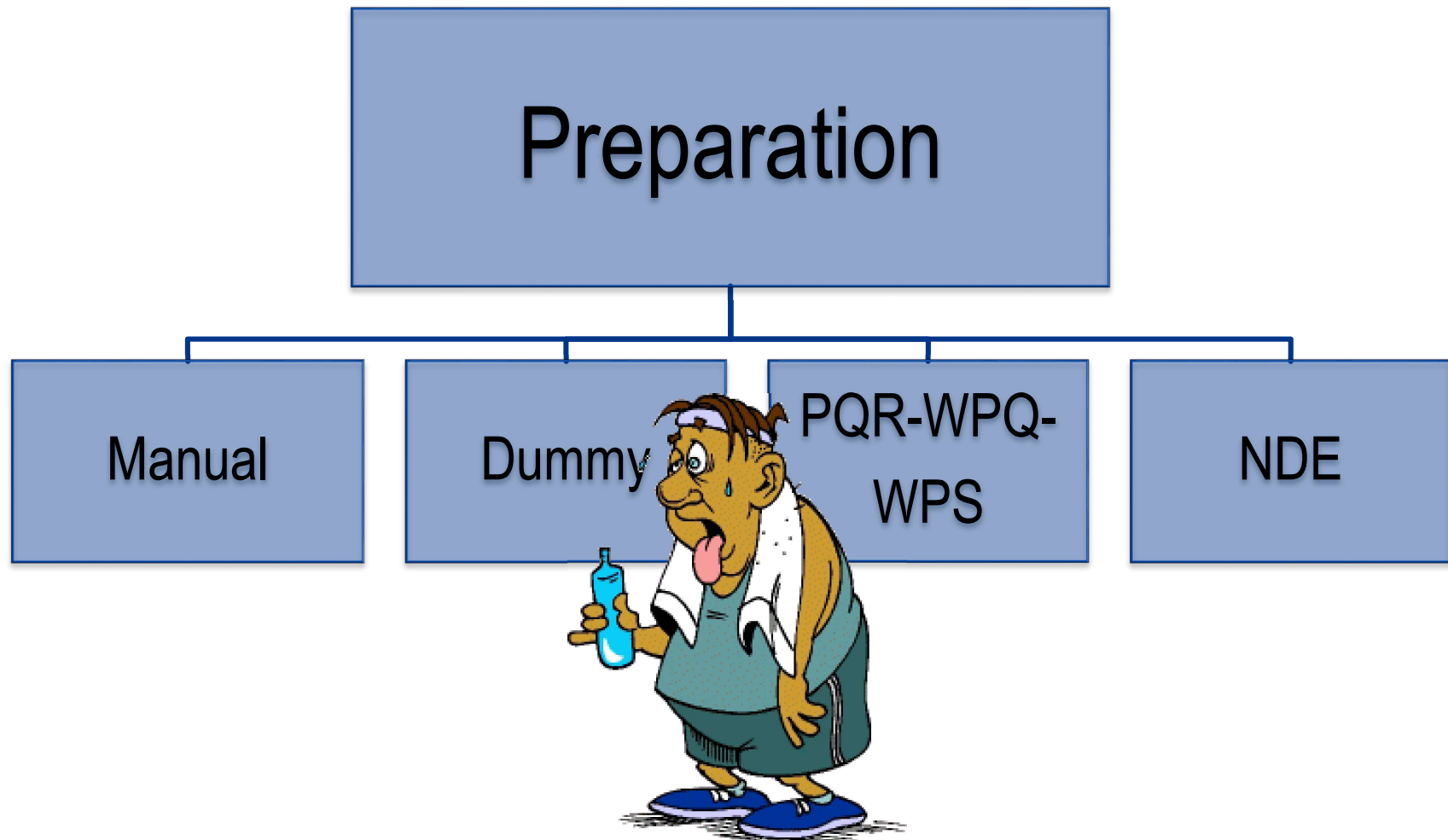

5

- Preparation for the Joint Review

Manual

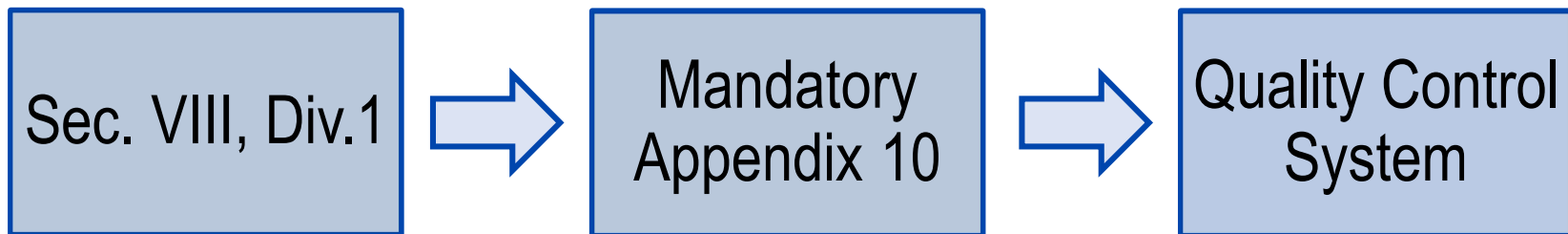



5

• Preparation for the Joint Review

Manual

- 1) Authority and Responsibility
- 2) Organization
- 3) Drawings, Design Calculations and Specification Control
- 4) Material Control
- 5) Examination and Inspection Program
- 6) Correction of Nonconformities
- 7) Welding



5

• Preparation for the Joint Review

Manual

- 8) Nondestructive Examination
- 9) Heat Treatment
- 10) Calibration of Measurement and Test Equipment
- 11) Records Retention
- 12) Sample Forms
- 13) Inspection of Vessels and Vessel Parts
-



5 • Preparation for the Joint Review

Dummy

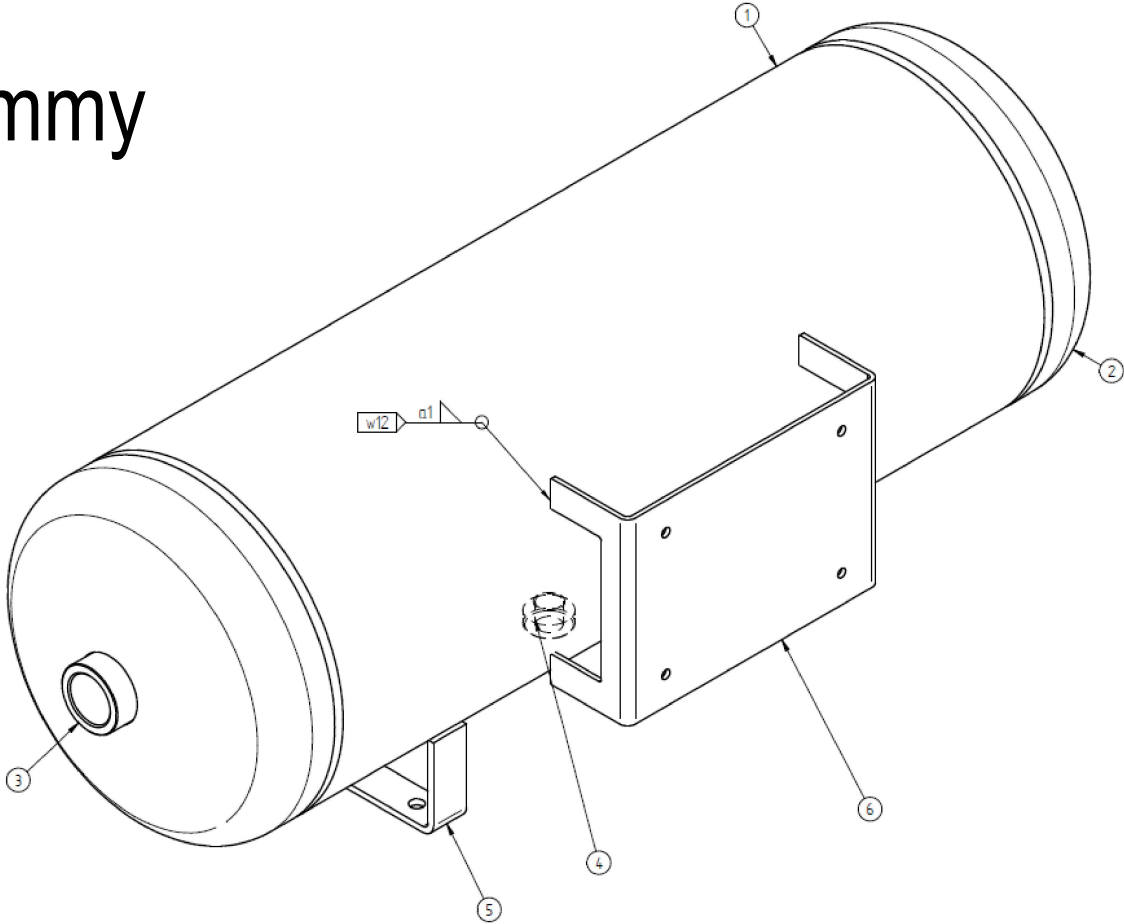



5

- Preparation for the Joint Review

PQR – WPQ - WPS

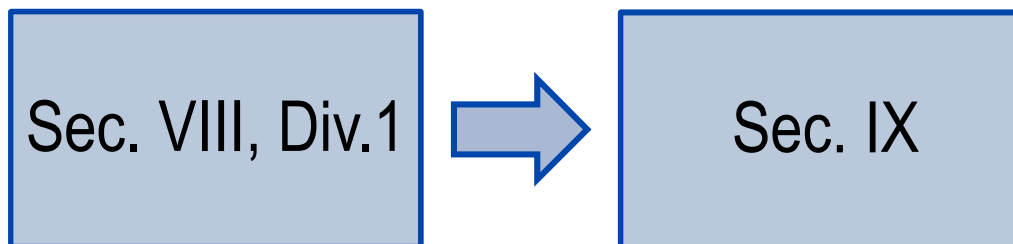

5

- Preparation for the Joint Review

NDE

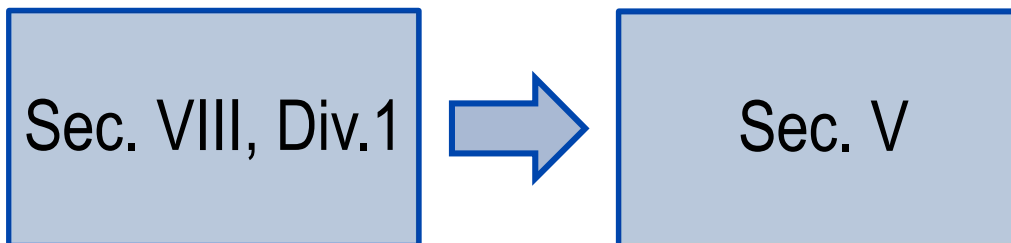



5

- Preparation for the Joint Review

NDE

www.asnt.org

✓ **Roland , Daniel** **ID# 206934** **(Munich Bavaria, GERMANY)**

| Program Type | Method | Sector | Technique | Expiration Date |
|--------------------|---------------------------|--------|-----------|-----------------|
| ASNT NDT Level III | Magnetic Particle Testing | | | 5/17 |
| ASNT NDT Level III | Liquid Penetrant Testing | | | 11/17 |
| ASNT NDT Level III | Radiographic Testing | | | 1/18 |

6

• Joint Review

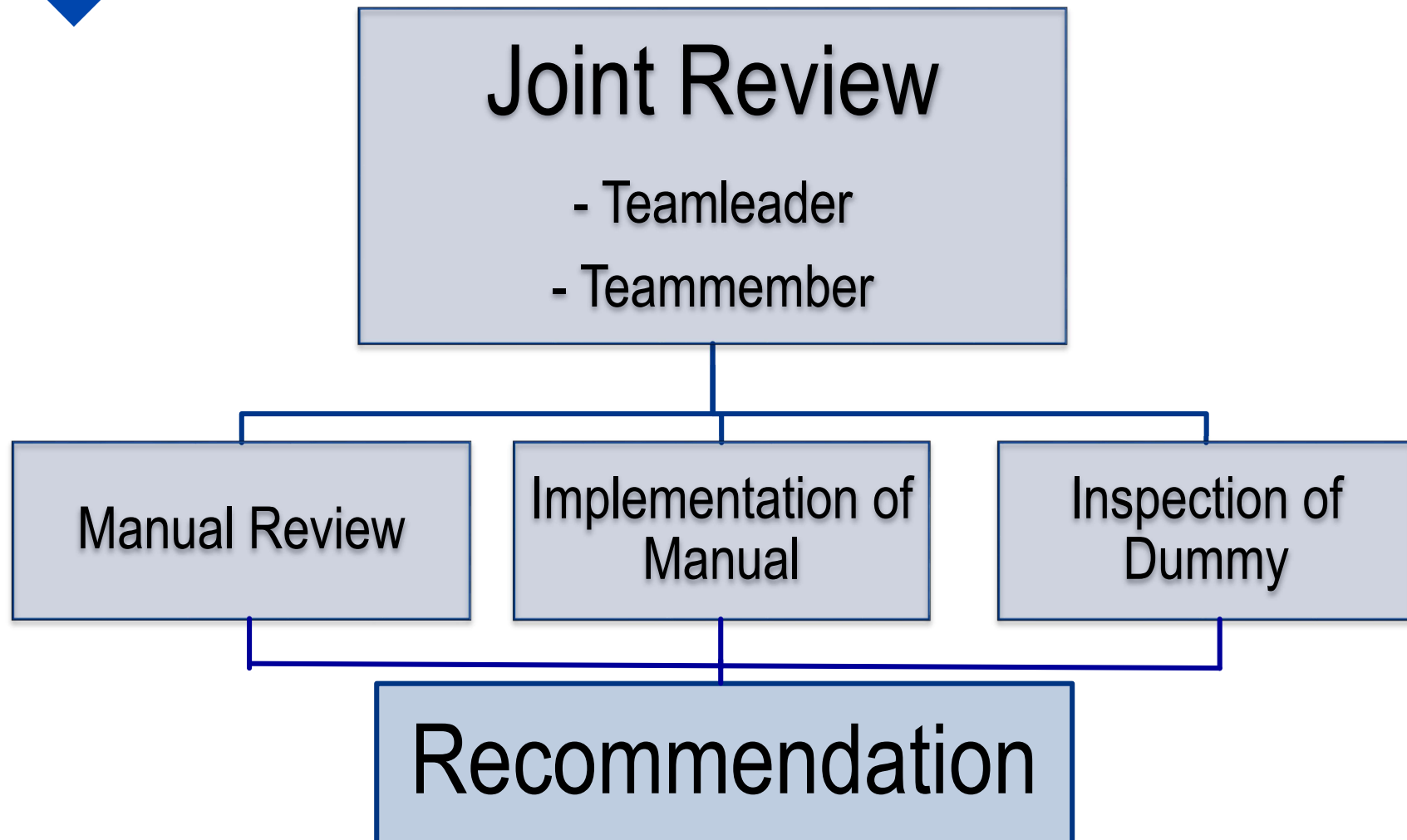



7

• Issue of Certificate

Certificate

Recommendation

Positive Decision for
Certification

Certificate

Hard Stamp

**Thanks for your
Attention!**

